

# SPICER®



J300P-2

March 2012

Supersedes Section 2

Dated January 2008

## Driveline Components Catalog Flange Yokes



Find the flange yokes that are built to your vehicle's original equipment specifications, based on the design and series of the part.



Product pictured is intended to be a representation of product category.

To identify a Flange Yoke, two pieces of information are needed:

1). The Design of the Part

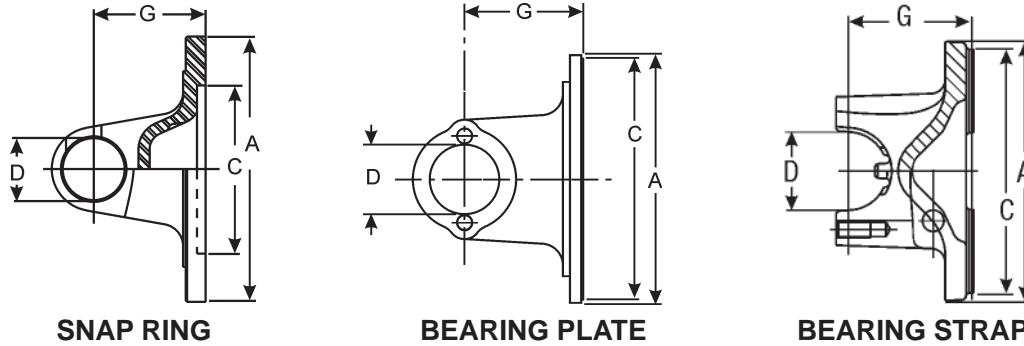

2). The Series of the Part

A Flange or Swing Diameter	B - Bolt Holes			C Pilot Diameter M-Male F-Female	Joint Angle	G Flange Face to Centerline	Illustration Figure	Spicer Part Number
	Bolt Circle Diameter	Bolt Hole Diameter	Number of Bolt holes					
<b>1310 SERIES (Continued)</b>								
	E-3.469			D-1.062		USE KIT NO. 5-153X, 5-785X, 5-801X		
5.2190	4.2500	.4840	4	2.0000F	19.0	1.6250	1	2-2-1379
<i>Bolt holes are equally spaced. Part has hole thru center.</i>								
5.7500	4.7500	.5070	4	3.7500M	20.0	1.3750	1	2-2-579
<b>1330 SERIES</b>								
	E-3.625			D-1.062		USE KIT NO. 5-213X, 5-790X, 5-812X		
4.4690	3.5000	.4840	4	2.0000F	—	1.6250	1	2-2-949
<i>Bolts holes are equally spaced</i>								
4.6250	3.7500	.4380	4	2.7500M	—	1.5620	1	2-2-1209
4.6250	3.7500	.4380	4	2.7500M	—	1.5620	1	2-2-1209

- SPL® flange yokes that are spring tab or strap design can be found on pages 3 through 4.
- Flange yokes that are snap ring or strap design can be found on pages 5 through 8.
- Flange yokes that are bearing plate design can be found on pages 9 through 11.
- A part number index is provided on page 12.

Footnotes for parts and assemblies that are discontinued, will be discontinued or replaced upon depletion of stock, or not sold separately, are indicated by a symbol next to the part number. Match the symbol to the appropriate status at the bottom of the page. All other footnotes are located immediately below the yoke dimensional data.



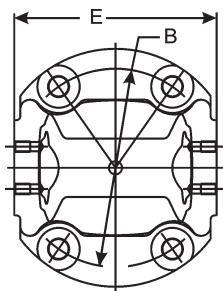

Figure 1

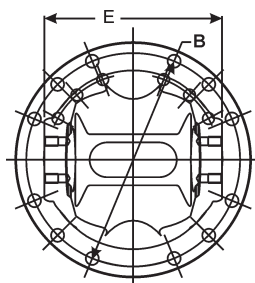

Figure 2

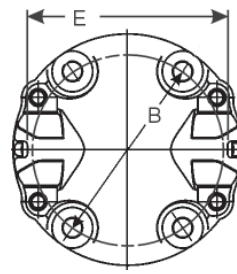
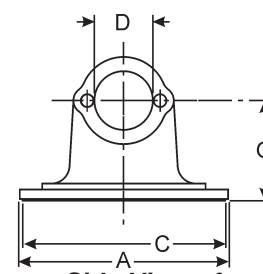

Figure 3



Side View of Figures 1, 2 & 4

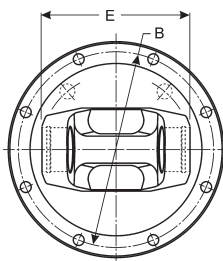

Figure 4

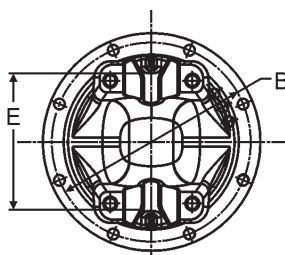

Figure 5

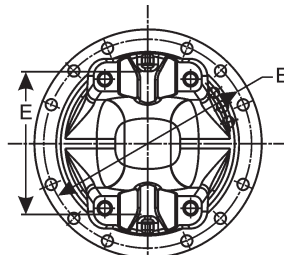
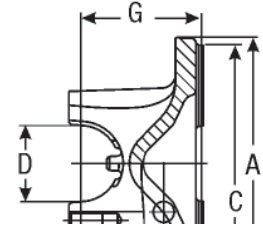

Figure 6



Side View of Figures 3, 5 & 6

A Flange or Swing Diameter	B - Bolt Holes		Number of Holes	C Pilot Diameter M-Male F-Female	G Flange Face to Centerline	Illustration Figure	Spicer Part Number
	Bolt Circle Diameter	Diameter D-Drilled T-Tapped					
<b>SPL90 SERIES E-5.380 (HR STYLE 4.958) D-1.625 USE KIT NO. SPL90X</b>							
5.906	5.118	.478-D	8	3.544F	3.281	2	90-2-29 <i>Metric flange</i>
6.688	6.124	.375-D	8	5.312M	2.750	5	90-2-49-1 <i>B.S./H.R.style w/brake pilot.</i>
6.688	6.124	.375-D	8	6.624M	3.280	2	90-2-19
8.000	7.250	.375-D	8	6.438M	2.750	5	90-2-39-1 <i>B.S./H.R.style w/brake pilot.</i>
8.000	7.250	.375-D	8	7.750M	2.750	5	90-2-69-1 <i>Bearing strap/half round style</i>
<b>SPL100 SERIES E-5.380 D-1.626 USE KIT SPL100-1X</b>							
8.000	7.250	.375-D	8	6.438M	2.750	5	100-2-169-1
8.000	7.250	.399-D	8	7.750M	3.250	4	100-2-159•
<b>SPL140 SERIES E-5.028 D-1.937 USE KIT SPL140-1X</b>							
8.000	7.250	.375-D	8	7.750M	3.070	5	140-2-99-1 <i>Mates with std. 1710 series companion flange</i>
8.000	7.250	.375-D	8	7.750M	3.070	2	140-2-59 <i>Mates with std. 1710 series companion flange</i>
8.000	7.250	.380-D	8	6.438M	2.953	5	140-2-69-1• <i>1/2 Rnd part W/spec GMC bolt hole size</i>
8.000	7.250	.396-D	12	7.750M	3.070	2	140-2-19• <i>10mm bolt holes on 1810 bolt pattern</i>
8.000	7.250	.439-D	12	7.750M	3.070	2	140-2-29• <i>Mates with std. 1810 series companion flange</i>
<b>SPL170 SERIES E-6.026 (HR STYLE 6.456) D-2.166 USE KIT SPL170X</b>							
7.087	5.906	.551-D	4	—	3.425	1	170-2-15 <i>180mm flange w/serrated flange face</i>
7.087	5.906	.551-D	4	—	4.311	5	170-2-35 <i>180mm flange w/serrated flange face</i>
8.000	7.250	.378-D	8	7.750M	3.208	4	170-2-49 <i>Mates with std. 1710 series companion flange</i>

Continued on next page

• Part is discontinued    ■ Part is available until supply is exhausted    ▲ Not sold separately



**Important: See Safety Information in General Information Section (J300P-GI)**

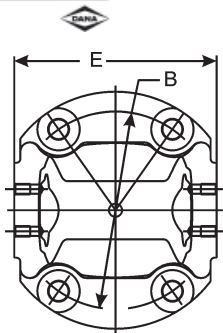

Figure 1

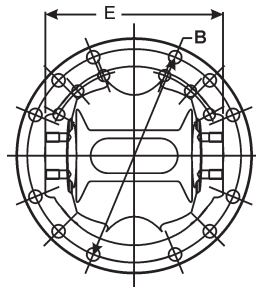

Figure 2

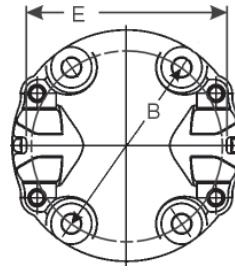
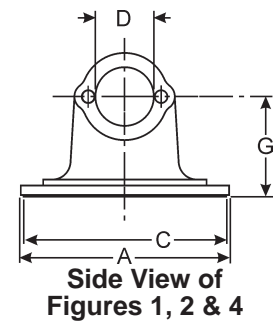

Figure 3



Side View of Figures 1, 2 & 4

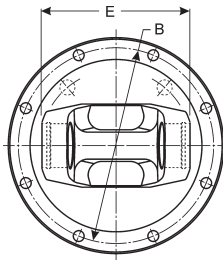

Figure 4

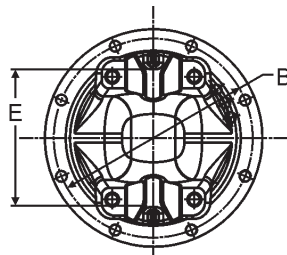

Figure 5

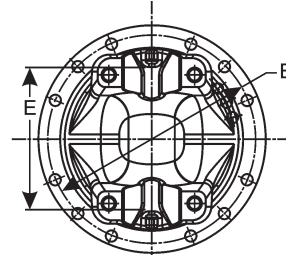
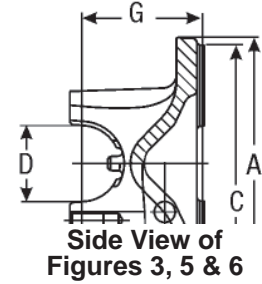

Figure 6



Side View of Figures 3, 5 & 6

A Flange or Swing Diameter	B - Bolt Holes			C Pilot Diameter M-Male F-Female	G Flange Face to Centerline	Illustration Figure	Spicer Part Number
	Bolt Circle Diameter	Diameter D-Drilled T-Tapped	Number of Holes				
<b>SPL170 SERIES (Continued) E-6.026 (HR STYLE 6.456) D-2.166 USE KIT SPL170X</b>							
8.000	7.250	.440-D	12	7.750M	3.386	6	170-2-59-1
8.000	7.250	.441-D	12	7.750M	3.208	2	170-2-19
8.000	7.250	.479-D	12	7.750M	3.208	2	170-2-29•
8.000	7.250	.479-D	12	7.750M	3.375	6	170-2-39-1
<i>Mates with std. 1810 series companion flange 12.2mm bolt holes on 1810 bolt pattern</i>							
<b>SPL250 SERIES E-5.986 D-2.362 USE KIT SPL250X</b>							
7.087	5.906	.591-D	4	—	3.583	5	250-2-10491-1
7.087	5.906	.551-D	4	—	3.583	1	250-2-15
8.000	7.250	.439-D	12	7.750M	3.500	2	250-2-19
<i>250-2-19 was replaced by 250-2-49-1 ; Mates with std. 1810 series companion flange</i>							
8.000	7.250	.440-D	12	7.750M	3.524	6	250-2-49-1
8.000	7.250	.479-D	12	7.750M	3.524	6	250-2-39-1
<i>Half round metric flange Half round metric flange</i>							

• Part is discontinued    ■ Part is available until supply is exhausted    ▲ Not sold separately



# Flange Yokes Snap Ring Design

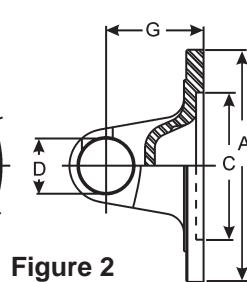
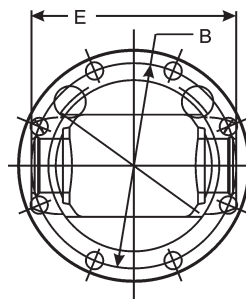
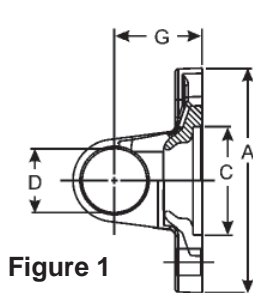
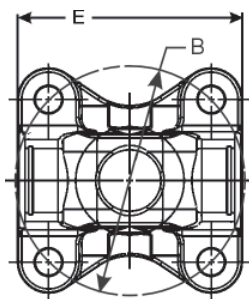

Figure 1

Figure 2

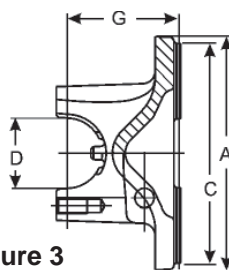
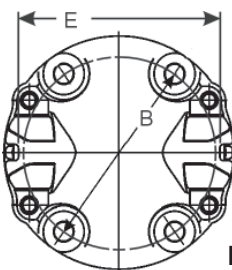

Figure 3

A Flange or Swing Diameter	B - Bolt Holes			C Pilot Diameter M-Male F-Female	G Flange Face to Centerline	Illustration Figure	Spicer Part Number
	Bolt Circle Diameter	Diameter D-Drilled T-Tapped	Number of Holes				
<b>1000 SERIES E-1.500 D-.938 USE KIT NO. 5-170X</b>							
3.375	2.750	.312-D	4	2.250M	1.562	1	10-2-29
<b>1100 SERIES E-2.656 D-.938 USE KIT NO. 5-101X OR 5-111X</b>							
3.375	2.750	.312-D	4	2.250F	1.188	1	1-2-49•
3.375	2.750	.312-D	4	2.250M	1.188	1	1-2-39
<b>1210 SERIES E-2.688 D-1.062 USE KIT NO. 5-443X OR 5-736X</b>							
3.406	2.750	.328-D	4	2.250M	1.484	1	2-2-899 <i>Fits several Nissan &amp; Toyota pick-up trucks</i>
3.710	3.125	.334-D	4	2.250M	1.200	1	2-2-1419• <i>Bolts holes are equally spaced</i>
3.710	3.125	.334-D	4	2.250M	1.200	1	2-2-1579 <i>2-2-1579 was replaced by 2-2-1419</i>
4.360	3.500	.484-D	4	2.000F	1.625	1	2-2-1049
<b>1310 SERIES E-3.469 D-1.062 USE KIT NO. 5-153X, 5-785X, 5-810X, 5-1200X</b>							
3.625	2.875	.380-D	4	—	1.375	1	2-2-349
3.875	3.125	.375-D	4	2.375F	1.375	1	2-2-389
3.875	3.125	.375-D	4	2.375M	1.625	1	2-2-459
3.875	3.125	.375-D	4	2.375M	1.375	1	2-2-329
3.875	3.125	.406-D	4	2.375M	1.625	1	2-2-1609 <i>Metric flange</i>
4.016	3.203	.406-D	4	1.969M	1.781	1	2-2-1309 <i>10 mm bolt holes, equally spaced</i>
4.080	3.198	.400-D	4	1.968M	1.781	1	2-2-1899
4.150	3.344	.406-D	4	1.812M	1.770	1	2-2-1679 <i>10 mm bolt holes, equally spaced</i>
4.158	3.346	.406-D	4	2.559M	1.766	1	2-2-1519
4.160	3.346	.406-D	4	2.375M	1.516	1	5006832 <i>5006832 was replaced by 2-2-06832</i>
4.160	3.346	.406-D	4	2.375M	1.516	1	2-2-06832
4.330	3.661	.446-D	4	1.811M	1.634	1	5001902 <i>5001902 was replaced by 2-2-01902 ; Bolts holes are equally spaced</i>
4.330	3.661	.446-D	4	1.811M	1.634	1	2-2-01902 <i>Bolts holes are equally spaced</i>

Continued on next page

- Part is discontinued
- Part is available until supply is exhausted
- ▲ Not sold separately



**Important: See Safety Information in General Information Section (J300P-GI)**

# Flange Yokes Snap Ring Design

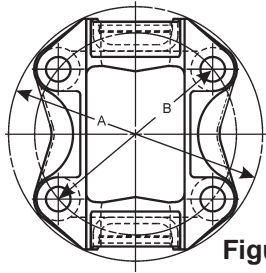

**Figure 1**

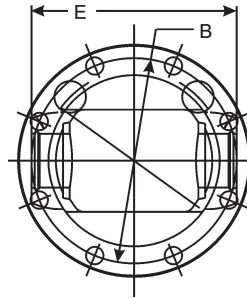
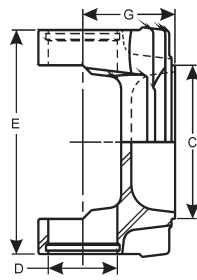

**Figure 2**

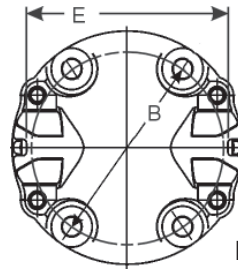
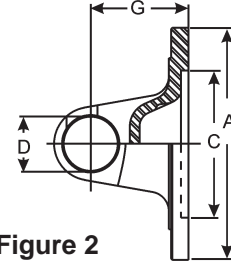

**Figure 3**

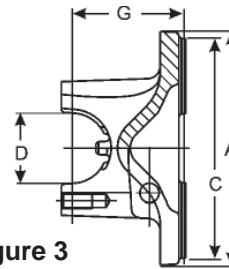

A Flange or Swing Diameter	B - Bolt Holes			C Pilot Diameter M-Male F-Female	G Flange Face to Centerline	Illustration Figure	Spicer Part Number
	Bolt Circle Diameter	Diameter D-Drilled T-Tapped	Number of Holes				
<b>1310 SERIES (Continued) E-3.469 D-1.062 USE KIT NO. 5-153X, 5-785X, 5-810X, 5-1200X</b>							
4.500	3.500	.500-D	4	2.000F	1.650	1	2-2-939
							<i>Bolt holes are equally spaced. Part has hole thru center.</i>
4.580	3.750	.440-D	4	2.750M	1.190	1	2-2-1039•
4.678	3.740	.469-D	4	2.558M	1.781	1	2-2-1729
4.625	3.750	.406-D	4	2.559M	1.772	1	2-2-1799
							<i>10 mm bolt holes, equally spaced</i>
4.625	3.750	.438-D	4	2.750M	1.375	1	2-2-479
4.719	3.750	.481-D	4	2.558M	1.781	1	2-2-1949
							<i>12 mm bolt holes equally spaced.</i>
4.740	3.740	.478-D	4	1.964M	1.780	1	2-2-2029
							<i>Bolts holes are equally spaced</i>
4.750	3.750	.503-D	4	2.750M	2.000	1	2-2-1789
							<i>10 mm bolt holes, equally spaced</i>
4.906	3.937	.489-D	4	2.162F	1.930	1	2-2-1989
							<i>Bolt holes are equally spaced. Part has hole thru center.</i>
5.219	4.250	.484-D	4	2.000F	1.625	1	2-2-1379
							<i>Bolt holes are equally spaced. Part has hole thru center.</i>
5.750	4.750	.507-D	4	3.750M	1.375	1	2-2-579
<b>1330 SERIES E-3.875 D-1.062 USE KIT NO. 5-213X, 5-790X, 5-812X, 5-1203X</b>							
3.880	3.000	.487-D	4	2.436F	1.618	1	2-2-01474
4.469	3.500	.484-D	4	2.000F	1.625	1	2-2-949
							<i>Bolts holes are equally spaced</i>
4.528	3.661	.446-D	4	1.811M	1.653	1	5001904
							<i>5001904 was replaced by 2-2-01904</i>
4.528	3.661	.446-D	4	1.811M	1.653	1	2-2-01904
4.625	3.750	.438-D	4	2.750M	1.562	1	2-2-1209
4.625	3.750	.438-D	4	2.750M	1.562	1	2-2-489
4.960	3.938	.489-D	4	2.161F	1.930	1	2-2-1879•
5.118	3.674	.482-D	4	1.811M	1.653	1	2-2-02768
							<i>Bolts holes are equally spaced</i>
5.156	4.250	.453-D	4	3.125F	1.688	1	2-2-1399
							<i>Bolts holes are equally spaced</i>

**Continued on next page**

• Part is discontinued    ■ Part is available until supply is exhausted    ▲ Not sold separately



# Flange Yokes Snap Ring Design

A Flange or Swing Diameter	B - Bolt Holes			C Pilot Diameter M-Male F-Female	G Flange Face to Centerline	Illustration Figure	Spicer Part Number
	Bolt Circle Diameter	Diameter D-Drilled T-Tapped	Number of Holes				
<b>1330 SERIES (Continued) E-3.875 D-1.062 USE KIT NO. 5-213X, 5-790X, 5-812X, 5-1203X</b>							
5.360	4.251	.500-D	4	2.560F	1.618	1	5002313 <i>5002313 was replaced by 2-2-02313</i>
5.360	4.251	.500-D	4	2.560F	1.618	1	2-2-02313
5.875	4.750	.500-D	4	2.953F	1.730	1	2-2-03489 <i>12 mm bolt holes equally spaced. Part has hole thru ctr.</i>
<b>1350 SERIES E-3.875 D-1.188 USE KIT NO. 5-178X OR 5-799X</b>							
4.500	3.750	.438-D	4	2.750M	1.281	1	3-2-809 <i>Bolt holes are equally spaced. Part has hole thru center.</i>
4.625	3.750	.438-D	4	2.750M	1.562	1	3-2-119
5.250	4.250	.470-T	4	2.680F	1.625	1	3-2-1699 <i>12mm threaded holes, Metric flange</i>
5.250	4.250	.500-D	4	2.000F	1.625	1	3-2-1579•
5.250	4.250	.500-D	4	2.560F	1.618	1	3-2-1879 <i>Bolt holes are equally spaced. Part has hole thru center.</i>
5.360	4.250	.472-T	4	2.000F	1.625	1	3-2-1619 <i>12mm threaded holes, Metric flange</i>
5.750	4.750	.500-D	4	2.953F	1.750	1	3-2-1859 <i>Bolt holes are equally spaced. Part has hole thru center.</i>
5.812	3.938	.489-D	4	2.161F	1.913	1	5010269• <i>Bolt holes are equally spaced. Part has hole thru center.</i>
6.406	5.500	.453-D	4	3.562F	1.844	1	3-2-699•
<b>1410 SERIES E-4.438 D-1.188 USE KIT NO. 5-160X OR 5-801X</b>							
4.234	3.750	.484-D	4	2.750M	1.688	1	3-2-1329
4.625	3.750	.438-D	4	2.750F	1.688	1	3-2-299
4.625	3.750	.438-D	4	2.750M	1.688	1	3-2-159
4.625	3.750	.438-D	4	2.750M	1.938	1	3-2-439
4.724	3.996	.394-D	8	2.954F	2.531	2	3-2-1159 <i>Metric flange</i>
4.760	3.938	.484-D	4	3.149M	1.690		3-2-1549 <i>Bolt holes are on 36 degrees</i>
5.094	4.750	.480-D	4	3.750M	1.750	2	3-2-1779
5.240	4.250	.500-D	4	2.000F	1.620	1	3-2-1819 <i>Part has hole thru center</i>
5.290	4.250	.500-D	4	2.560F	1.736	1	3-2-04617 <i>Bolts holes are equally spaced</i>
5.352	4.250	.512-D	4	2.680F	1.620	1	3-2-1759 <i>Bolt holes are equally spaced. Part has hole thru center.</i>
5.352	4.250	.472-T	4	2.680F	1.620	1	3-2-1709 <i>12mm tapped holes/OEM only</i>
5.750	4.750	.500-D	4	2.953F	2.000	1	3-2-1839 <i>Bolt holes are equally spaced. Part has hole thru center.</i>
5.750	4.750	.509-D	4	3.750M	2.000	1	3-2-1789 <i>Bolts holes are equally spaced</i>
5.812	4.750	.531-D	4	3.750M	2.000	1	3-2-939
5.875	4.750	.480-D	4	3.750M	2.000	1	3-2-1519•
5.875	4.750	.500-D	4	3.750M	2.000	1	3-2-429
5.875	4.750	.500-D	4	3.750M	1.750	1	3-2-549
5.875	4.750	.500-D	4	3.750M	1.500	1	3-2-559 <i>12mm threaded holes equally spaced</i>
6.375	5.500	.438-D	4	3.562F	1.844	1	3-2-709
6.750	5.750	.484-D	4	4.803F	2.000	3	3-2-1659-1 <i>Bearing strap style yoke w/brake pilot and bolt pattern</i>
6.875	6.125	.375-D	8	6.875M	2.000	2	3-2-309 <i>Flange has pilot for brake</i>

• Part is discontinued    ■ Part is available until supply is exhausted    ▲ Not sold separately



**Important: See Safety Information in General Information Section (J300P-GI)**

# Flange Yokes Snap Ring Design

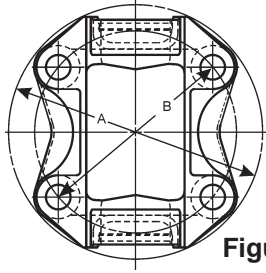

**Figure 1**

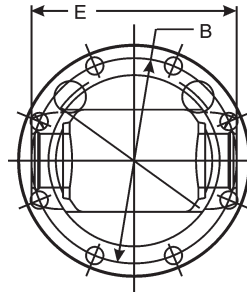
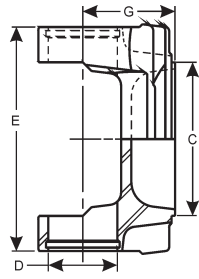

**Figure 2**

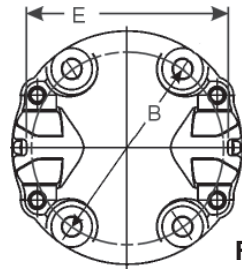
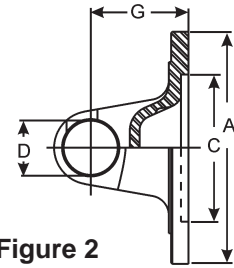

**Figure 3**

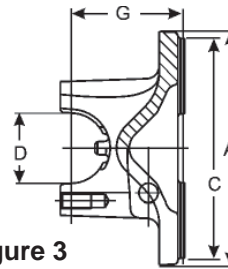

A Flange or Swing Diameter	B - Bolt Holes			C Pilot Diameter M-Male F-Female	G Flange Face to Centerline	Illustration Figure	Spicer Part Number
	Bolt Circle Diameter	Diameter D-Drilled T-Tapped	Number of Holes				
<b>1480 SERIES E-4.438 D-1.375 USE KIT NO. 5-188X, 5-803X OR 5-804X</b>							
5.354	4.252	.509-D	4	2.680F	1.800	1	3-2-1769
5.750	4.750	.500-D	4	3.750M	2.000	1	3-2-479
5.850	4.750	.510-D	4	2.953F	2.000	1	3-2-1869
5.875	4.250	.472-T	4	2.680F	1.800	1	3-2-1719
5.875	4.750	.500-D	4	3.750M	2.000	1	3-2-609
5.875	4.750	.500-D	4	3.750M	1.500	1	3-2-489
6.875	6.125	.386-D	8	5.312M	1.938	2	3-2-909
6.875	6.125	.386-D	8	6.625M	2.000	2	3-2-499
<b>1550 SERIES E-5.250 D-1.375 USE KIT NO. 5-155X, 5-808X OR 5-809X</b>							
4.724	3.996	.400-D	8	2.953F	3.150	1	4-2-1129
5.750	4.750	.484-D	4	3.750M	1.500	1	4-2-1149
5.750	4.750	.500-D	4	3.750M	2.000	1	4-2-819
5.760	4.724	.559-D	4	3.750M	2.000	1	5001720
5.760	4.724	.559-D	4	3.750M	2.000	1	5001720 was replaced by 4-2-01720
5.774	4.750	.512-D	4	3.750M	2.000	1	4-2-669
5.875	4.750	.500-D	4	3.750F	1.500	1	4-2-759
5.875	4.750	.500-D	4	3.750M	1.500	1	4-2-679
6.156	5.250	.453-D	8	3.750F	2.500	2	4-2-829
6.412	5.500	.453-D	8	3.750F	2.500	2	4-2-849
6.875	6.125	.375-D	8	6.625M	2.000	2	4-2-689
6.875	6.125	.386-D	8	5.312M	2.000	2	Flange has pilot for brake 4-2-699
6.875	6.125	.406-D	8	5.312M	2.000	2	Flange has pilot for brake 4-2-1109
7.000	6.124	.509-D	8	3.375F	2.000	2	4-2-1159

• Part is discontinued    ■ Part is available until supply is exhausted    ▲ Not sold separately





# Flange Yokes Bearing Plate Design

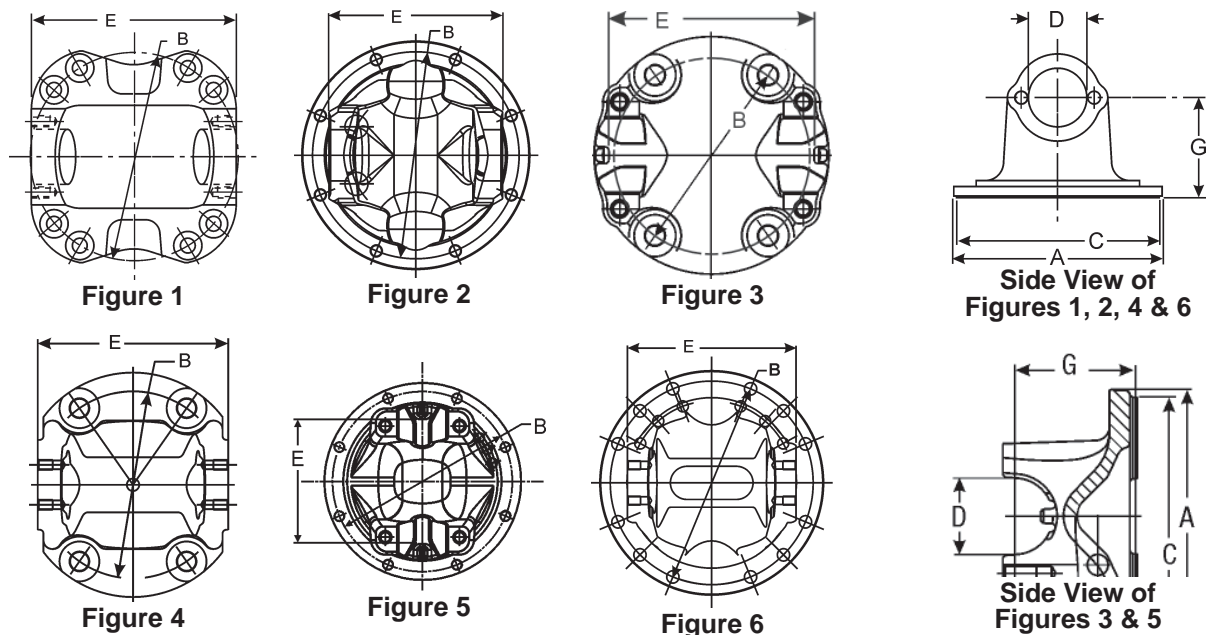

A Flange or Swing Diameter	B - Bolt Holes		C Pilot Diameter M-Male F-Female	G Flange Face to Centerline	Illustration Figure	Spicer Part Number
	Bolt Circle Diameter	Diameter D-Drilled T-Tapped				
<b>1610 SERIES</b>						
<b>E-5.312 D-1.875 USE KIT NO. 5-279X, 5-674X</b>						
6.875	6.125	.375-D	8	5.312M	2	5-2-599 <i>Flange has pilot for brake</i>
6.875	6.125	.375-D	8	5.312M	2	5-2-989 <i>Flange has pilot for brake</i>
6.875	6.125	.375-D	8	5.312M	5	5-2-599-1 <i>B.S./H.R.style w/brake pilot.</i>
6.875	6.125	.375-D	8	5.375F	2	5-2-1089 <i>Part has opening cast thru web</i>
6.875	6.125	.375-D	8	5.375F	2	5-2-249
6.875	6.125	.375-D	8	6.625M	2	5-2-279
6.875	6.125	.375-D	8	6.625M	2	5-2-379
6.875	6.125	.440-D	12	6.625M	6	5-2-1159*
8.000	7.250	.375-D	8	6.435M	5	5-2-1249-1 <i>B.S./H.R.style w/brake pilot.</i>
8.000	7.250	.375-D	8	6.435M	3	5-2-709-1* <i>B.S./H.R.style w/brake pilot.</i>
8.000	7.250	.375-D	8	6.435M	2	5-2-709 <i>Flange has pilot for brake</i>
8.000	7.250	.375-D	8	7.750M	2	5-2-629
8.000	7.250	.375-D	8	7.750M	2	5-2-619 <i>Part has opening cast thru web</i>
<b>1710 SERIES</b>						
<b>E-6.094 (HR STYLE-6.190) D-1.938 USE KIT NO. 5-280X, 5-675X</b>						
7.087	5.906	.590-D	4	.000	4	6-2-25 <i>180 mm flange w/serrated flange face</i>
8.000	5.118	.472-D	4	.000	4	6-2-15 <i>150 mm flange w/serrated flange face</i>
8.000	7.250	.375-D	8	6.438M	5	6-2-1439-1 <i>B.S./H.R.style w/brake pilot.</i>
8.000	7.250	.375-D	8	6.438M	2	6-2-789 <i>Flange has pilot for brake</i>
8.000	7.250	.375-D	8	7.750M	2	6-2-769
8.000	7.250	.375-D	8	7.750M	5	6-2-749-1 <i>Part has opening cast thru web</i>

Continued on next page

• Part is discontinued    ■ Part is available until supply is exhausted    ▲ Not sold separately



**Important: See Safety Information in General Information Section (J300P-GI)**

# Flange Yokes Bearing Plate Design

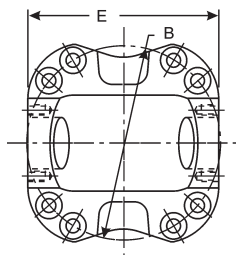

Figure 1

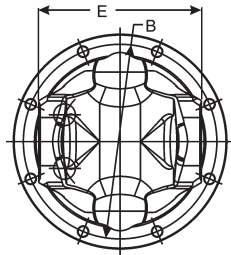

Figure 2

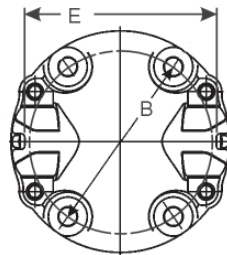

Figure 3

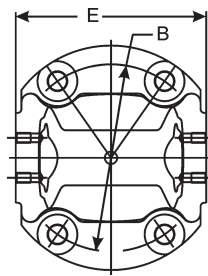
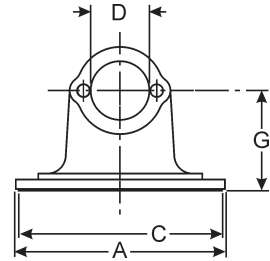

Figure 4



Side View of  
Figures 1, 2, 4, 6 & 8

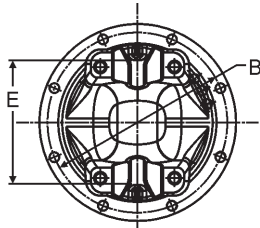

Figure 5

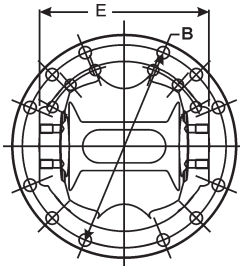

Figure 6

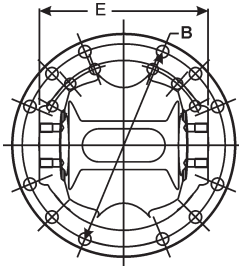

Figure 7

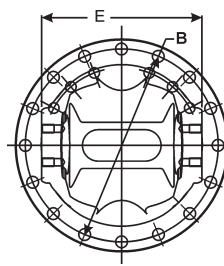
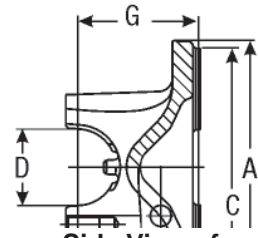

Figure 8



Side View of  
Figures 3, 5 & 7

A Flange or Swing Diameter	B - Bolt Holes			C Pilot Diameter M-Male F-Female	G Flange Face to Centerline	Illustration Figure	Spicer Part Number
	Bolt Circle Diameter	Diameter D-Drilled T-Tapped	Number of Holes				
<b>1710 SERIES (Continued) E-6.094 (HR STYLE-6.190) D-1.938 USE KIT NO. 5-280X, 5-675X</b>							
8.000	7.250	.375-D	8	7.750M	3.000	2	6-2-749
8.000	7.250	.375-D	8	7.750M	2.000	2	6-2-959• <i>Part has opening cast thru web</i>
8.000	7.250	.375-D	8	7.750M	3.000	2	6-2-1239 <i>Bolts rotated 22.5 degrees for brake applications</i>
8.000	7.250	.375-D	8	8.000M	3.000	2	6-2-759 <i>Flange has pilot for brake</i>
8.000	7.250	.396-D	12	7.750M	3.000	5	6-2-14898 <i>10 mm bolt holes, equally spaced</i>
8.000	7.250	.438-D	16	6.438M	3.000	8	6-2-1219 <i>Flange has pilot for brake</i>
8.000	7.250	.438-D	12	7.750M	3.000	6	6-2-779 <i>Flange has pilot for brake</i>
8.000	7.250	.438-D	8	7.750M	3.000	5	6-2-739-1
8.000	7.250	.438-D	8	7.750M	2.500	2	6-2-1349 <i>Part has opening cast thru web</i>
8.000	7.250	.438-D	8	7.750M	3.000	2	6-2-739
8.000	7.250	.438-D	8	7.750M	3.000	2	6-2-1159 <i>Part has opening cast thru web</i>
8.000	7.250	.438-D	12	7.750M	3.000	7	6-2-779-1 <i>Flange has pilot for brake; Bearing strap/half round style</i>
8.000	7.250	.438-D	12	7.750M	2.000	6	6-2-839
<b>1760 SERIES E-7.000 (HR STYLE-7.094) D-1.938 USE KIT NO. 5-407X, 5-677X</b>							
8.000	7.250	.438-D	12	7.750M	3.375	6	6.3-2-19
8.000	7.250	.438-D	12	7.750M	3.375	7	6.3-2-19-1 <i>Bearing strap/half round style</i>
<b>1810 SERIES E-7.547 (HR STYLE-7.643) D-1.938 USE KIT NO. 5-281X, 5-676X</b>							
8.000	7.250	.438-D	12	6.438M	3.312	4	6.5-2-349
8.000	7.250	.438-D	12	7.750M	3.375	6	6.5-2-329
8.000	7.250	.438-D	12	7.750M	3.375	7	6.5-2-329-1
8.125	7.250	.438-D	12	7.750M	2.594	6	6.5-2-359

• Part is discontinued    ■ Part is available until supply is exhausted    ▲ Not sold separately



# Flange Yokes Bearing Plate Design

A	B - Bolt Holes			C	G	Illustration Figure	Spicer Part Number
Flange or Swing Diameter	Bolt Circle Diameter	Diameter D-Drilled T-Tapped	Number of Holes	Pilot Diameter M-Male F-Female	Flange Face to Centerline		
<b>1880 SERIES</b>		<b>E-8.094 D-2.188 USE KIT NO. 5-308X</b>					
9.562	8.250	.625-D	8	7.000M	2.500	1	8-2-119
9.562	8.250	.625-D	8	7.000M	3.500	1	8-2-109

• Part is discontinued    ■ Part is available until supply is exhausted    ▲ Not sold separately



**Important: See Safety Information in General Information Section (J300P-GI)**

1-2-39 .....5	3-2-489 .....8	5-2-599 .....9
1-2-49• .....5	3-2-499 .....8	5-2-599-1 .....9
2-2-329 .....5	3-2-549 .....7	5-2-619 .....9
2-2-349 .....5	3-2-559 .....7	5-2-629 .....9
2-2-389 .....5	3-2-609 .....8	5-2-709-1• .....9
2-2-459 .....5	3-2-699• .....7	5-2-709 .....9
2-2-479 .....6	3-2-709 .....7	5-2-989 .....9
2-2-489 .....6	3-2-809 .....7	5-2-1089 .....9
2-2-579 .....6	3-2-909 .....8	5-2-1159• .....9
2-2-899 .....5	3-2-939 .....7	5-2-1249-1 .....9
2-2-939 .....5	3-2-1159 .....7	6-2-15 .....9
2-2-949 .....6	3-2-1329 .....7	6-2-25 .....9
2-2-1049 .....5	3-2-1519• .....7	6-2-739-1 .....10
2-2-1209 .....6	3-2-1549 .....7	6-2-739 .....10
2-2-1309 .....5	3-2-1579• .....7	6-2-749-1 .....9
2-2-1379 .....6	3-2-1619 .....7	6-2-749 .....10
2-2-1399 .....6	3-2-1659-1 .....7	6-2-759 .....10
2-2-01474 .....6	3-2-1699 .....7	6-2-769 .....9
2-2-1519 .....5	3-2-1719 .....8	6-2-779 .....10
2-2-1579 .....5	3-2-1759 .....7	6-2-779-1 .....10
2-2-1609 .....5	3-2-1769 .....8	6-2-789 .....9
2-2-1679 .....5	3-2-1779 .....7	6-2-839 .....10
2-2-1729 .....6	3-2-1789 .....7	6-2-959• .....10
2-2-1789 .....6	3-2-1819 .....7	6-2-1159 .....10
2-2-1799 .....6	3-2-1839 .....7	6-2-1219 .....10
2-2-1899 .....5	3-2-1859 .....7	6-2-1239 .....10
2-2-01902 .....6	3-2-1869 .....8	6-2-1349 .....10
2-2-01904 .....6	3-2-1879 .....7	6-2-1439-1 .....9
2-2-1949 .....6	3-2-04617 .....7	6-2-14898 .....10
2-2-1989 .....6	4-2-669 .....8	6.3-2-19 .....10
2-2-2029 .....6	4-2-679 .....8	6.3-2-19-1 .....10
2-2-02313 .....7	4-2-689 .....8	6.5-2-329 .....10
2-2-02768 .....6	4-2-699 .....8	6.5-2-329-1 .....10
2-2-03489 .....7	4-2-759 .....8	6.5-2-349 .....10
2-2-06832 .....5	4-2-819 .....8	6.5-2-359 .....10
2-2-1039• .....6	4-2-829 .....8	8-2-109 .....11
2-2-1419• .....5	4-2-849 .....8	8-2-119 .....11
2-2-1879• .....6	4-2-1109 .....8	10-2-29 .....5
3-2-119 .....7	4-2-1129 .....8	90-2-19 .....3
3-2-159 .....7	4-2-1149 .....8	90-2-39-1 .....3
3-2-299 .....7	4-2-1159 .....8	90-2-49-1 .....3
3-2-309 .....7	4-2-01720 .....8	90-2-69-1 .....3
3-2-429 .....7	5-2-249 .....9	90-2-29 .....3
3-2-439 .....7	5-2-279 .....9	100-2-159• .....3
3-2-479 .....8	5-2-379 .....9	100-2-169-1 .....3





140-2-19•	3
140-2-29•	3
140-2-59	3
140-2-69-1•	3
140-2-99-1	3
170-2-15	3
170-2-19	4
170-2-29•	4
170-2-35	3
170-2-39-1	4
170-2-49	3
170-2-59-1	4
250-2-15	4
250-2-19	4
250-2-39-1	4
250-2-49-1	4
250-2-10491	4
5001720	8
5001902	5
5001904	6
5002313	7
5006832	5
5010269•	7





Dana Holding Corporation strives to publish catalogs that are as accurate and user-friendly as possible. Continuous improvement is our ongoing mission. Therefore, we welcome any and all of your comments. Please forward your comments with any suggested improvements or corrections to our Catalog Department via Fax or mail.

**Fax:** Product Management / Catalog Department  
(419) 866-3925

**Mail:** Dana Holding Corporation  
Aftermarket Group  
Attn: Product Management / Catalog Department  
PO Box 321  
Toledo, OH 43697-0321

Comments and Suggested Improvement/Corrections	Page Number	Part Number



**Dana Aftermarket Group**  
PO Box 1000  
Maumee, Ohio 43537

Warehouse Distributors: 1.800.621.8084  
OE Dealers: 1.877.777.5360

[www.SpicerParts.com](http://www.SpicerParts.com)

**SPICER**<sup>®</sup>

---



J300P-2 Printed in U.S.A.  
Copyright Dana Limited, 2014.  
All rights reserved. Dana Limited.

